

Quantum Algorithms for the Monte Carlo Method

Yassine HAMOUDI

Soutenance de thèse présentée
le 7 juillet 2021

A concrete example: **Molecular Dynamics**

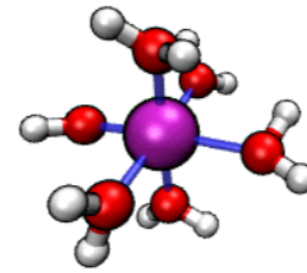

- Protein folding
- Drug design
- Nanotechnologies
- ...

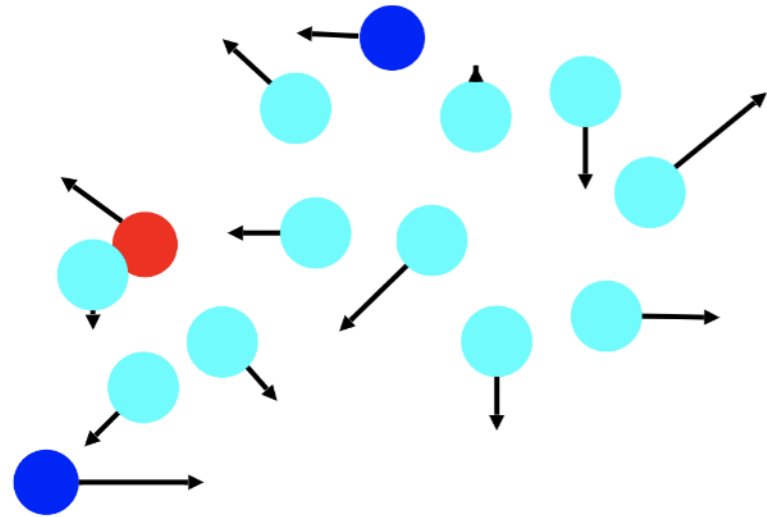

Simulate trajectories and interactions of molecules

Bottleneck: performances (time, memory, ...) scale **exponentially** with number of particles

→ Classical computers are not suited to simulate the laws of quantum mechanics (*language barrier*)

→ New algorithmic methods adapted to **quantum computers**

Monte Carlo

Statistical analysis



Random sampling



Approximation methods

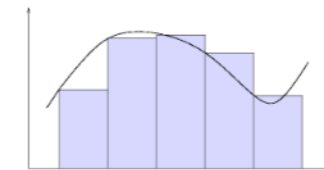

Quantum computing

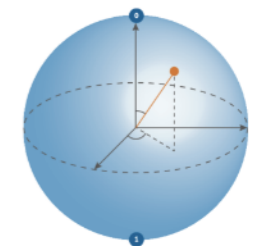

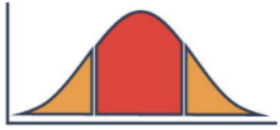

Estimating Statistics

- Y. Hamoudi and F. Magniez. “Quantum Chebyshev’s Inequality and Applications”, ICALP 2019.
- Y. Hamoudi. “Quantum Sub-Gaussian Mean Estimator”, ESA 2021.
- Y. Hamoudi and F. Magniez. “Quantum Approximate Triangle Counting”. In submission.



Random Sampling

- Y. Hamoudi, P. Reberntrost, A. Rosmanis, and M. Santha. “Quantum and Classical Algorithms for Approximate Submodular Function Minimization”, *Quantum Information & Computation*.
- P. Reberntrost, Y. Hamoudi, M. Ray, X. Wang, S. Yang, M. Santha. "Quantum algorithms for hedging and the learning of Ising models", *Physical Review A*.



Small-Memory Algorithms

- Y. Hamoudi and F. Magniez. “Quantum Chebyshev’s Inequality and Applications”, ICALP 2019.
- Y. Hamoudi and F. Magniez. “Quantum Time-Space Tradeoff for Finding Multiple Collision Pairs”, TQC 2021.

Estimating Statistics

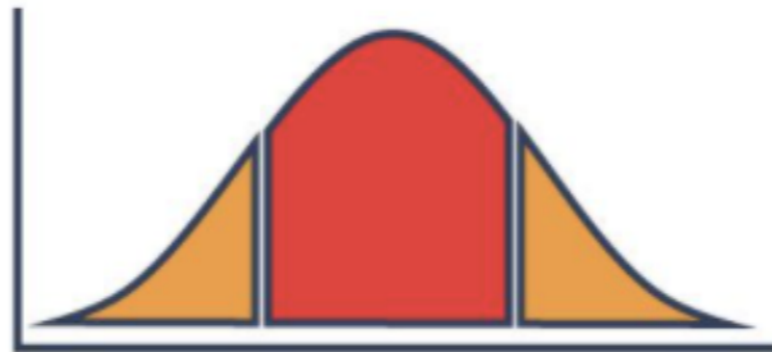

Quantum simulation & Expectation estimation

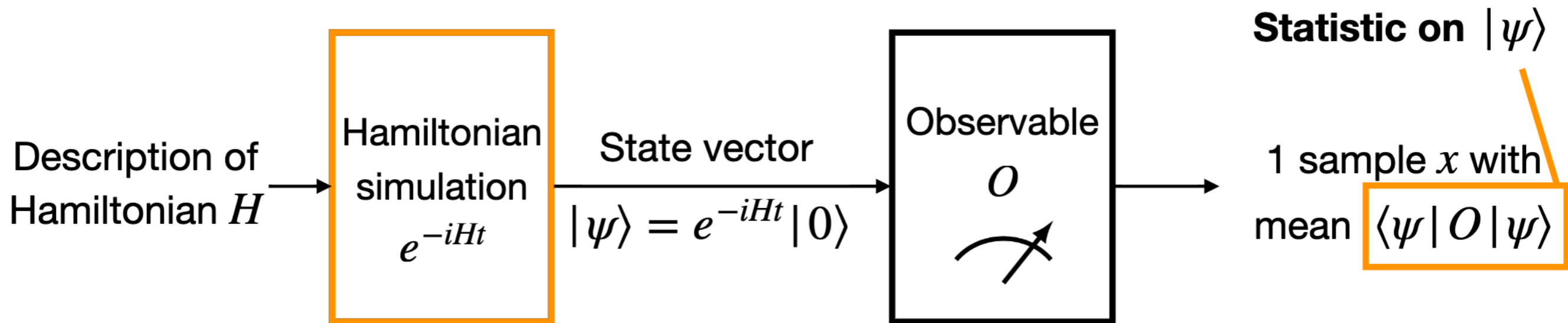

1 experiment \$

What is the best possible estimate $\tilde{\mu}$ of $\langle\psi|O|\psi\rangle$ that can be computed by running n experiments?

Output sample distribution

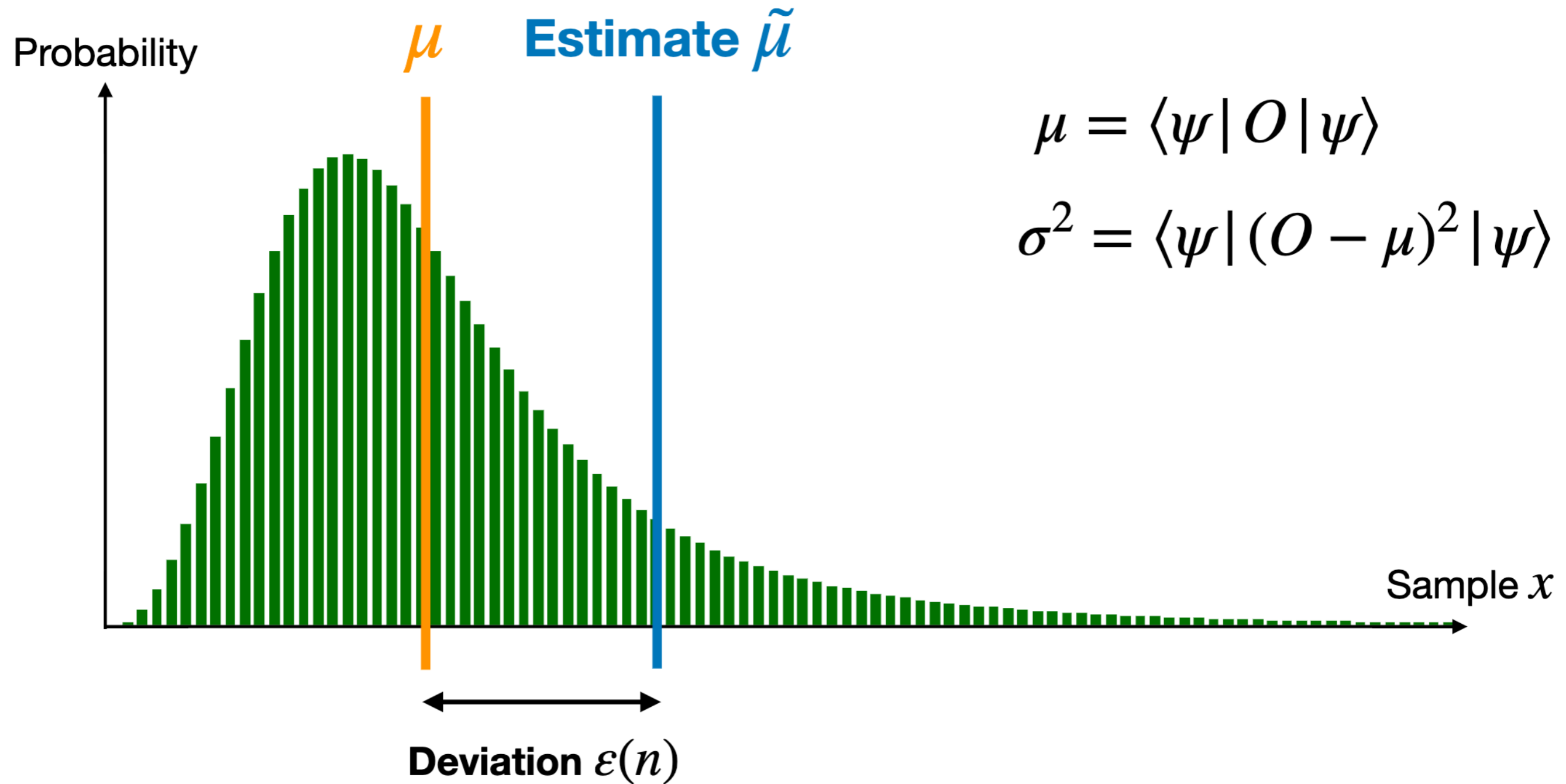

Objective: minimize the deviation $\varepsilon(n)$ for n experiments

Classical estimators

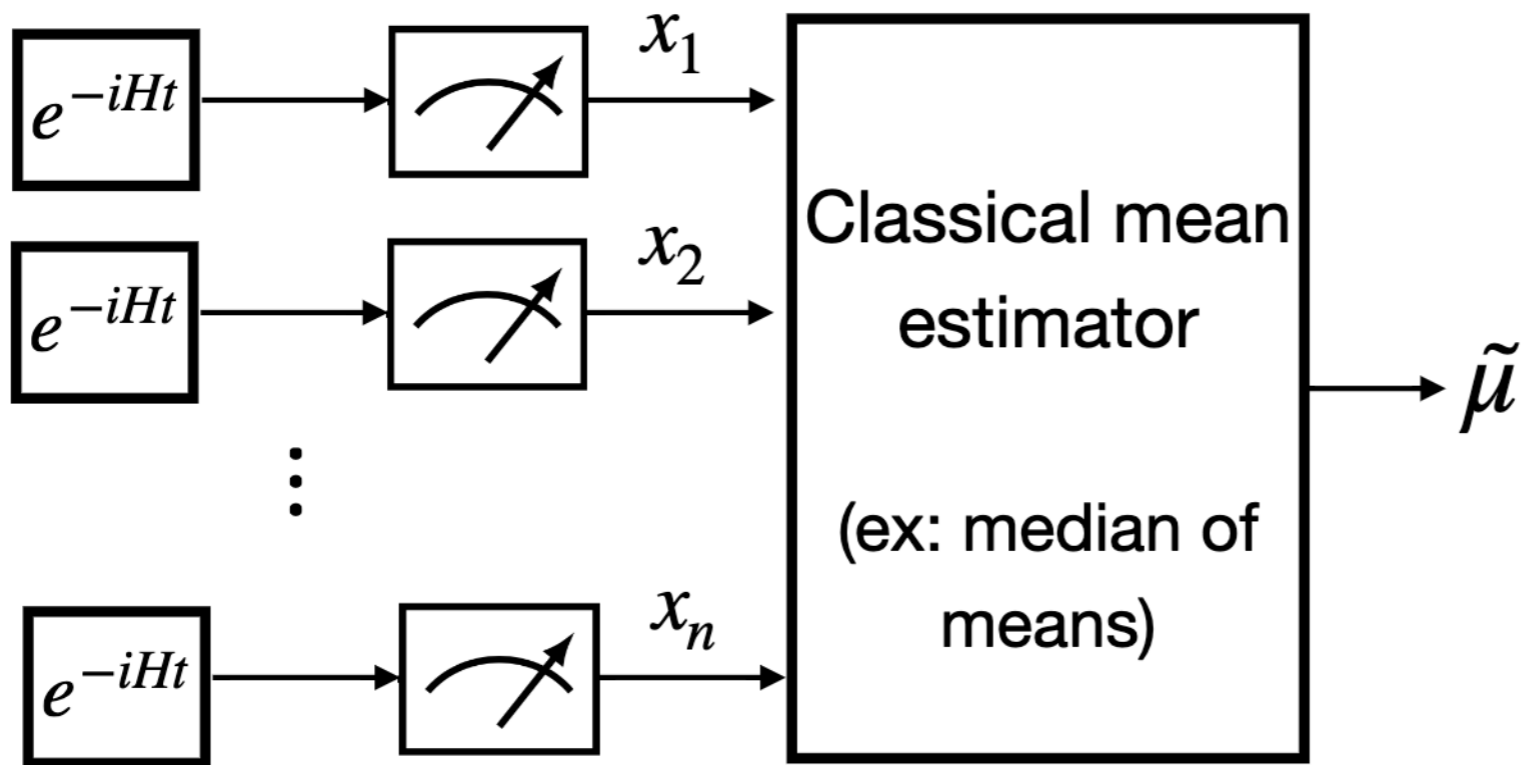

$$\varepsilon(n) \approx \frac{\sigma}{\sqrt{n}}$$

Quantum estimators

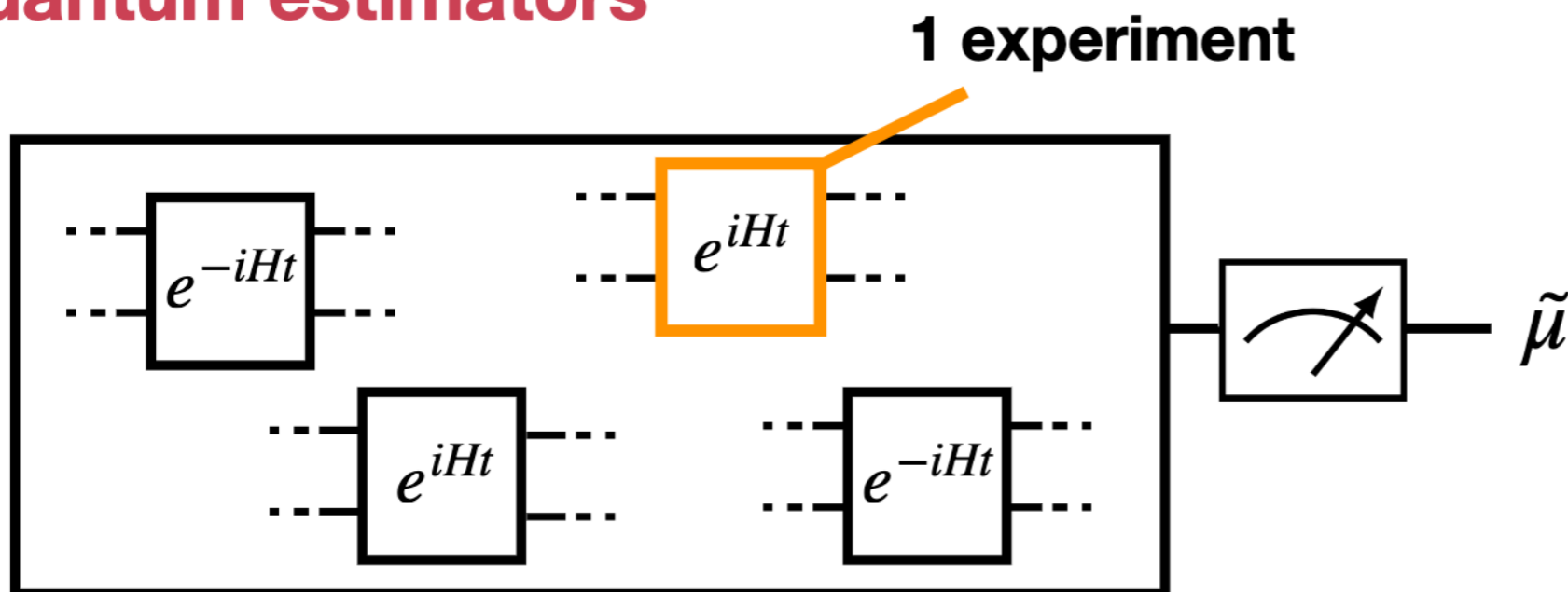

Previous work:

- Suboptimal in σ
[Gro98, Ter99, AW99, BDGT11]
- Parametrized by σ
[Hei02, Mon15, HM19]

Classical estimators

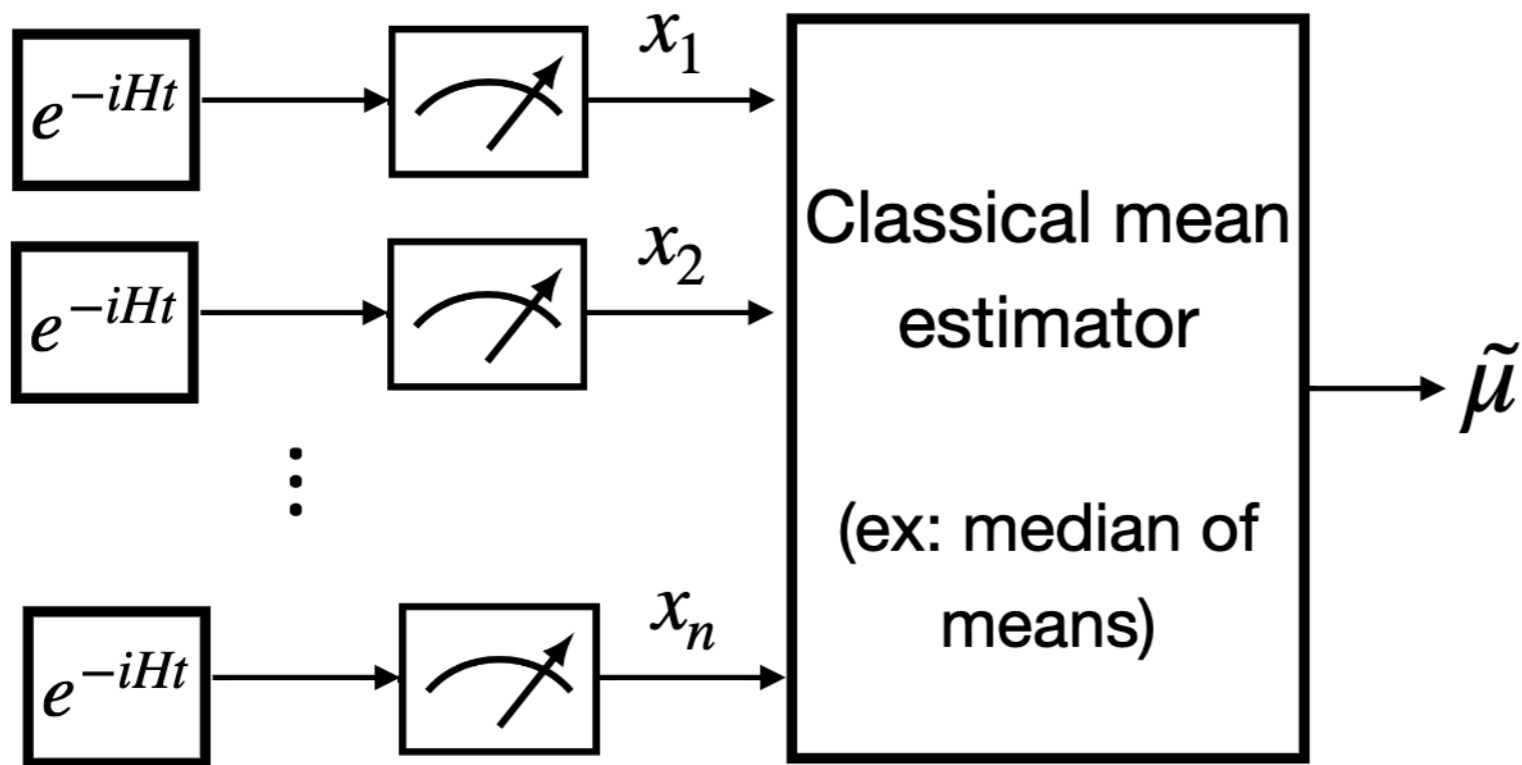

$$\varepsilon(n) \approx \frac{\sigma}{\sqrt{n}}$$

Quantum estimators

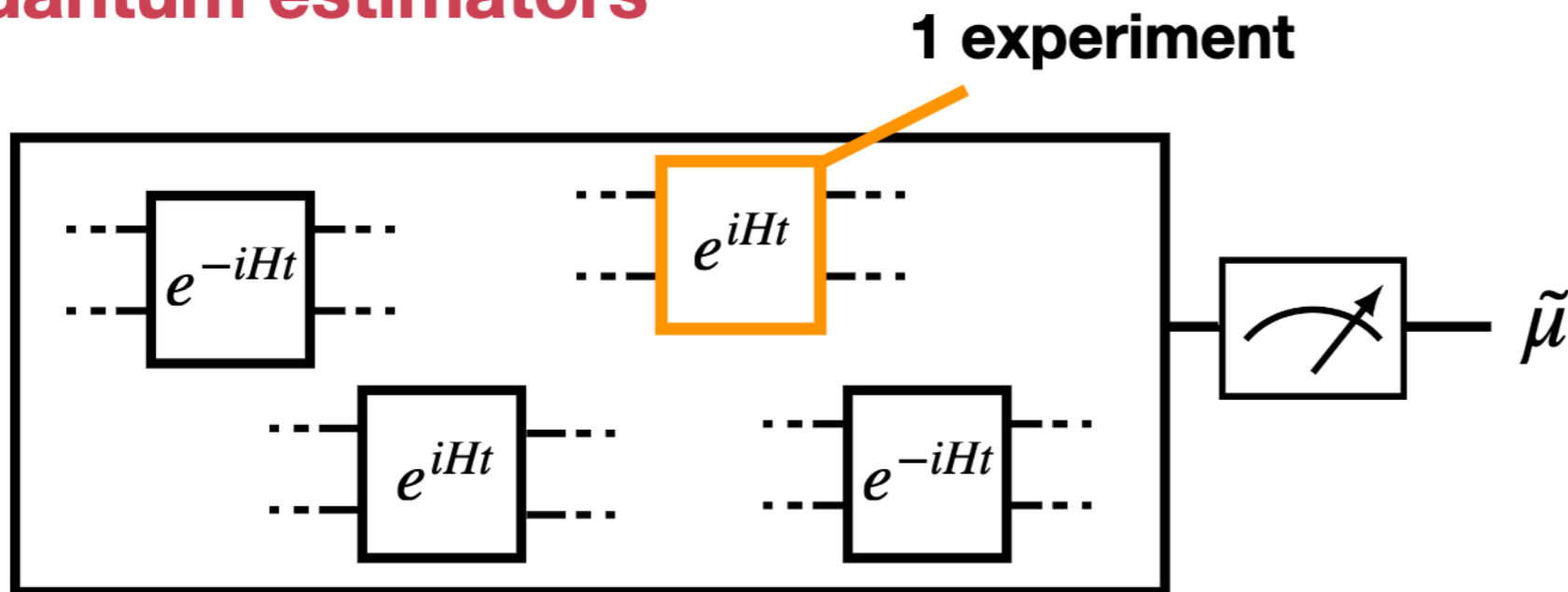

$$\varepsilon(n) \approx \frac{\sigma}{n}$$



Techniques

Truncated Mean Estimation:

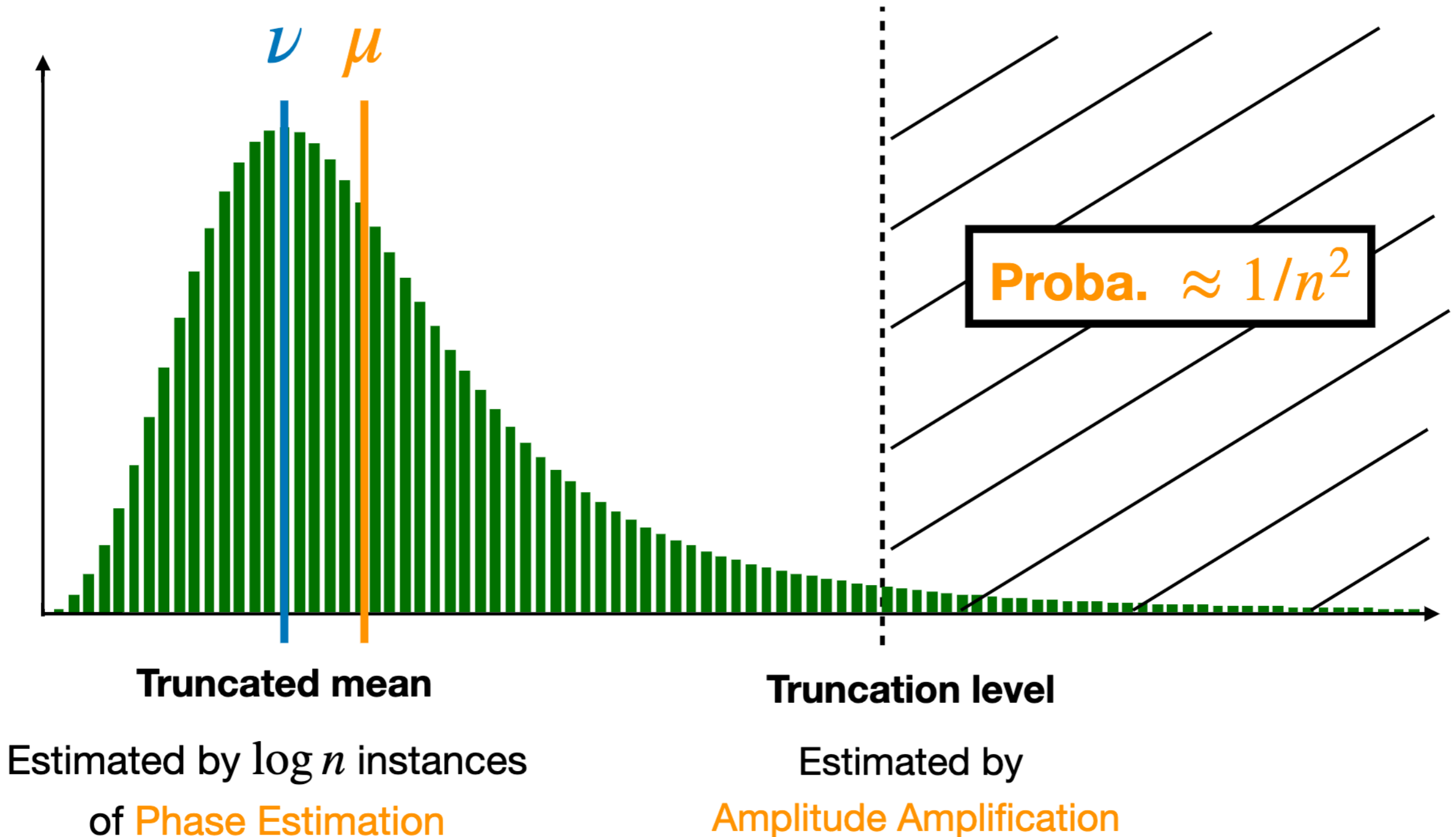

Random Sampling



Goal: generate random samples given the **description** of a distribution p



$$x_1, x_2, \dots \sim p$$

Distribution p

A quantum approach: Prepare-and-measure a quantum state encoding the target distribution

$$|p\rangle = \sum_x \sqrt{p_x} |x\rangle \quad (\mathbf{q\text{-}sample})$$

- Time to prepare $|p\rangle$ with a quantum computer can be **smaller** than time to sample p with a classical computer.
- Q-samples are important for quantum linear algebra, quantum walks, ...

Black-box state preparation

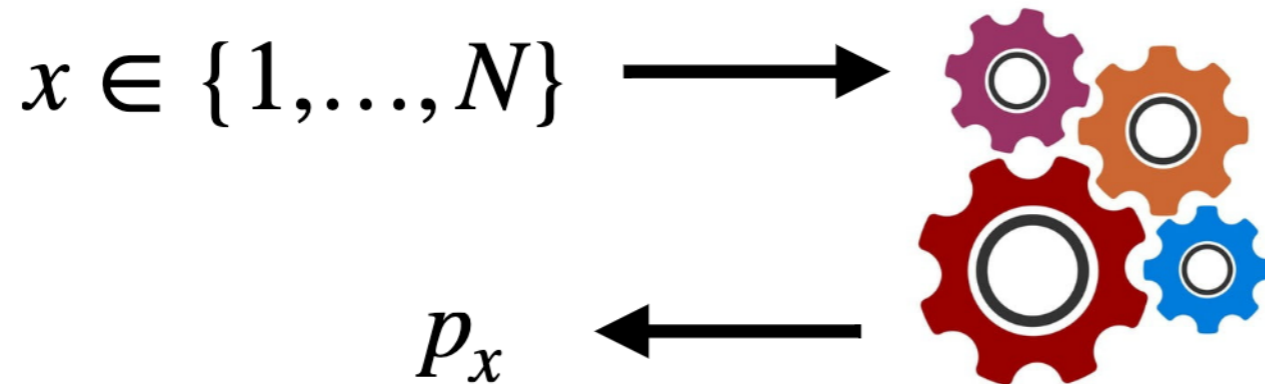

Each probability can be generated quickly

(oracle $x \mapsto p_x$)

How much **time** do we need to prepare $|p\rangle$?

Cost for 1 copy

[Gro00]

$$\Theta(\sqrt{N})$$

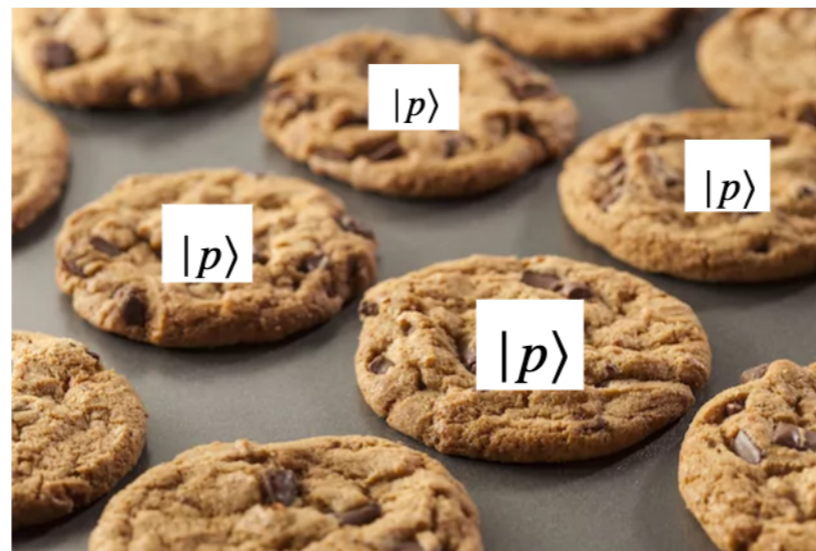

Cost for K copies

$$O(K\sqrt{N}) ?$$

$$\Theta(\sqrt{KN})$$



Techniques

Quantum Rejection Sampling method:

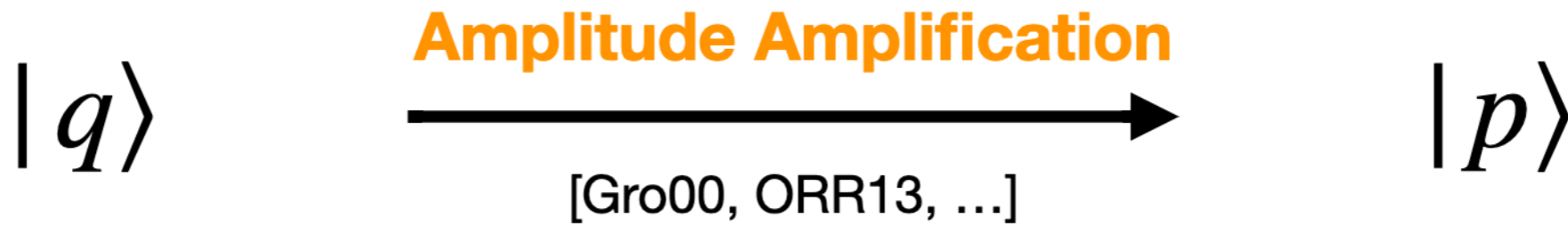







Easy to prepare
(ex: uniform distribution)

Objective state

↑ Select $|q\rangle$ with
larger $|\langle q|p\rangle|$

Precompute the K
largest entries in p

Energy stocks

				
 Day 1	10%	45%	25%	20%
 Day 2	5%	35%	30%	30%
 Day 3	?	?	?	?

Online prediction with expert advice

Radio tower placement

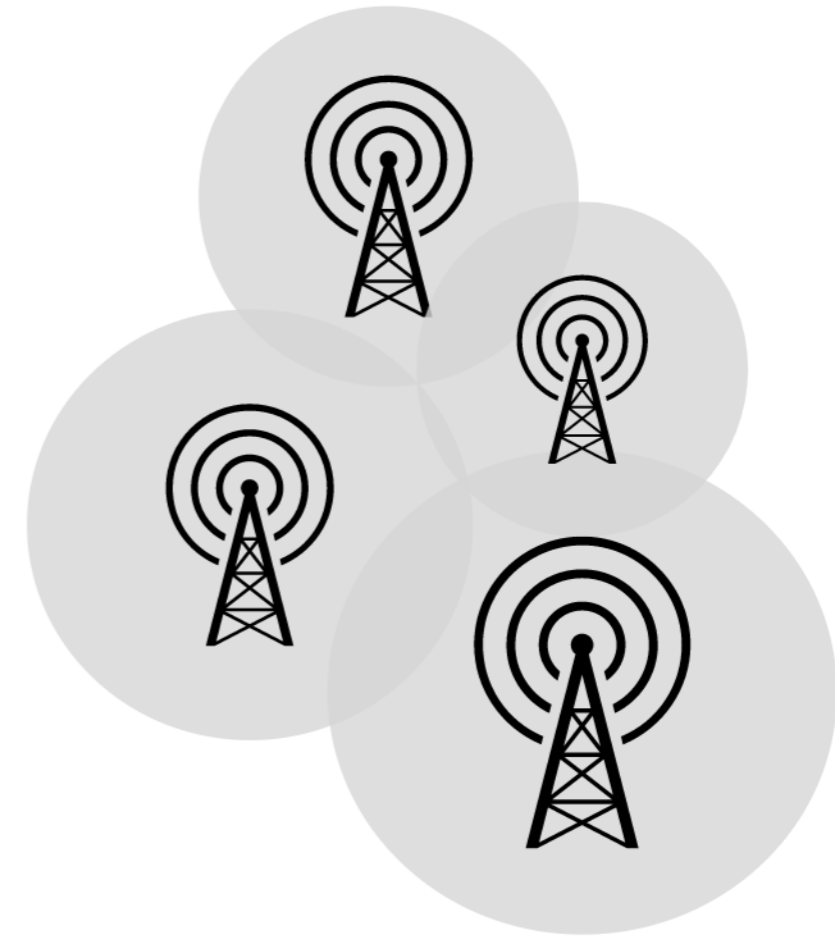

Submodular function minimization

Iterative updates: $x^{(1)} \longrightarrow x^{(2)} \longrightarrow \dots \longrightarrow x^{(t)}$

Random update by **sampling**
from a distribution $p^{(t)}$

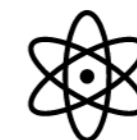

Quantum speedup

Energy stocks

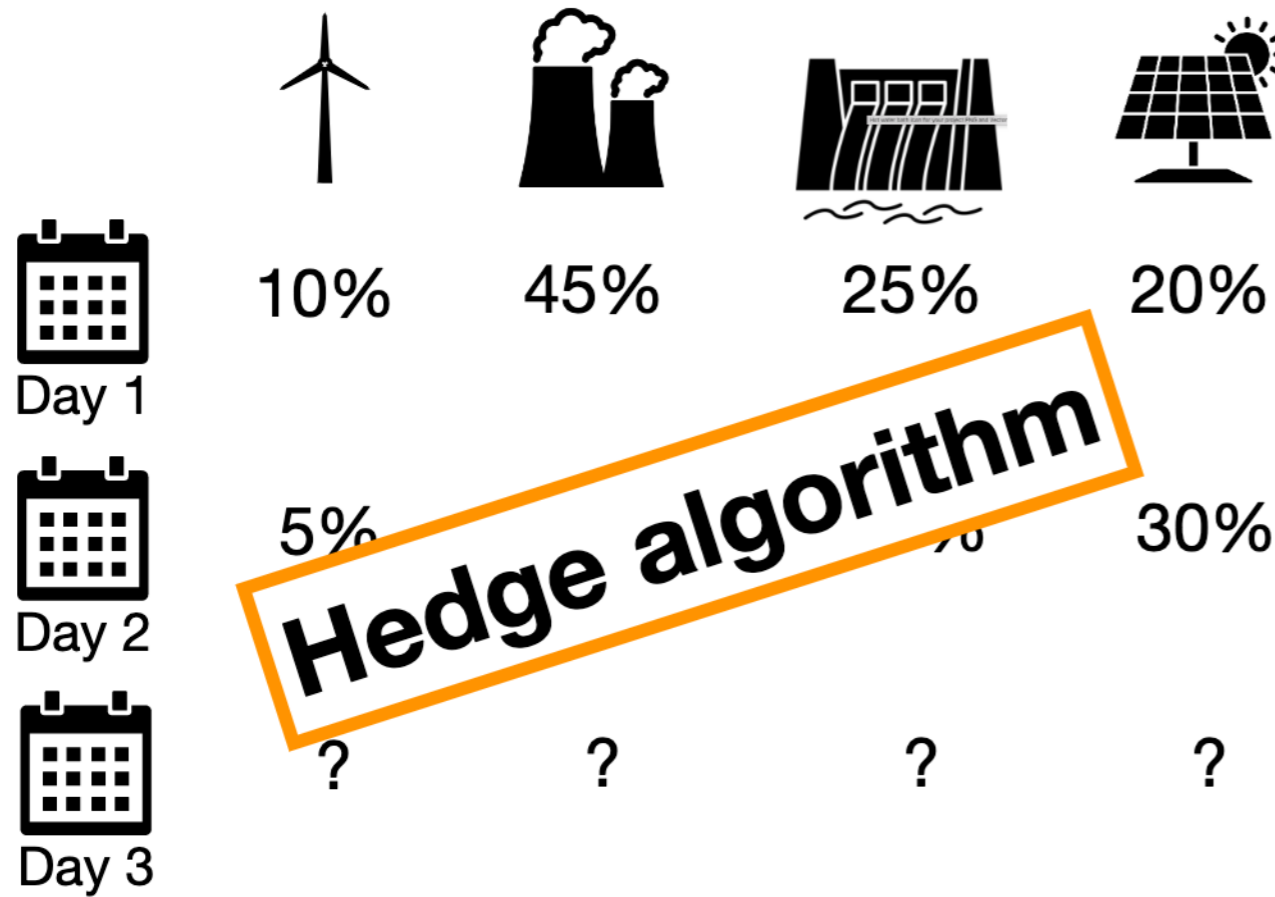

Online prediction with expert advice

Radio tower placement

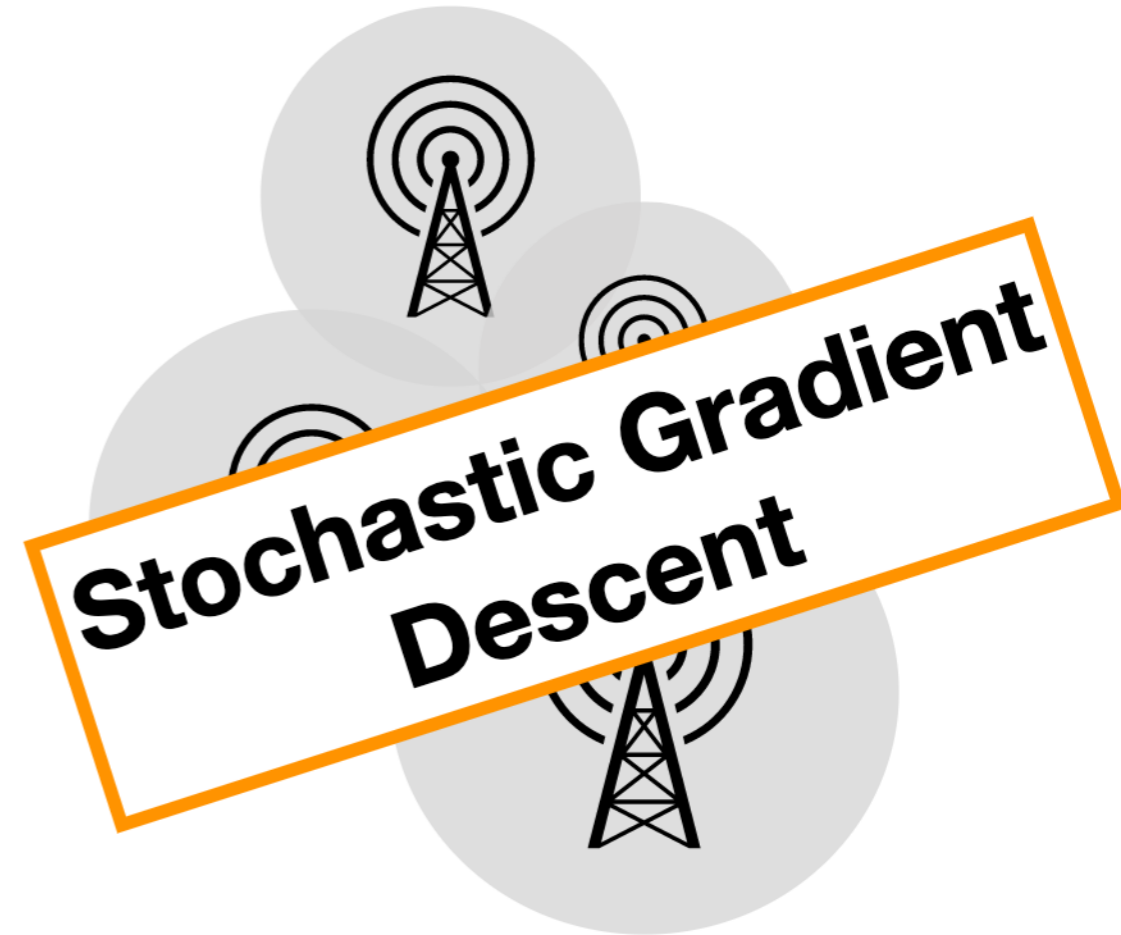

Submodular function minimization

Iterative updates: $x^{(1)} \longrightarrow x^{(2)} \longrightarrow \dots \longrightarrow x^{(t)}$

Random update by **sampling**
from a distribution $p^{(t)}$

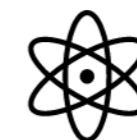

Quantum speedup

Small-Memory Algorithms





Memory: most critical computational resource?

- Size of datasets keeps increasing (network traffic, particle physics experiments,...)
- Processor-memory bottleneck: bandwidth/latency improve at a slower rate than processor speed
- Near-term quantum computers will have small and error-prone memories

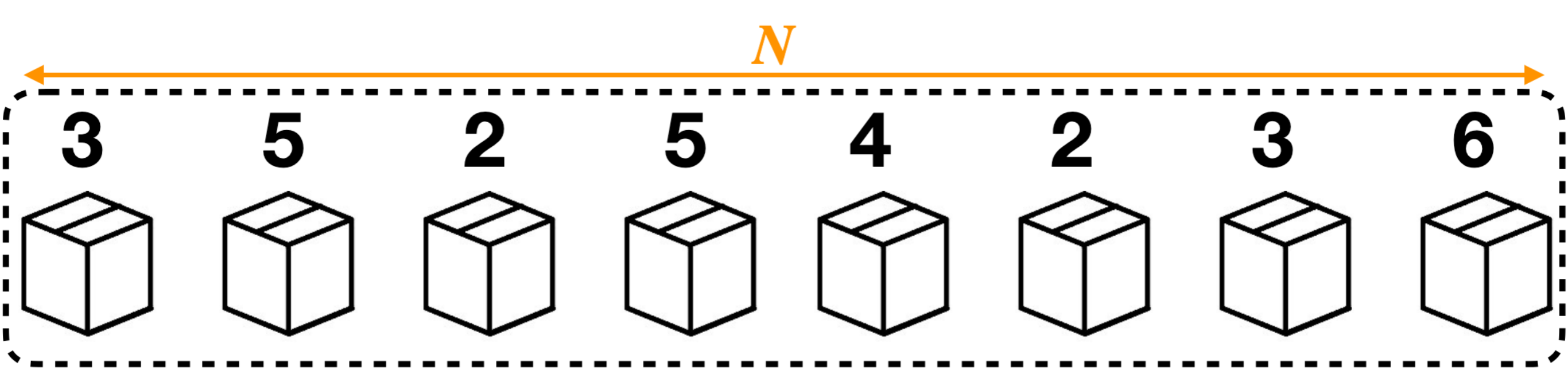

Database



Small computer

with memory of size $\Theta(\log N)$

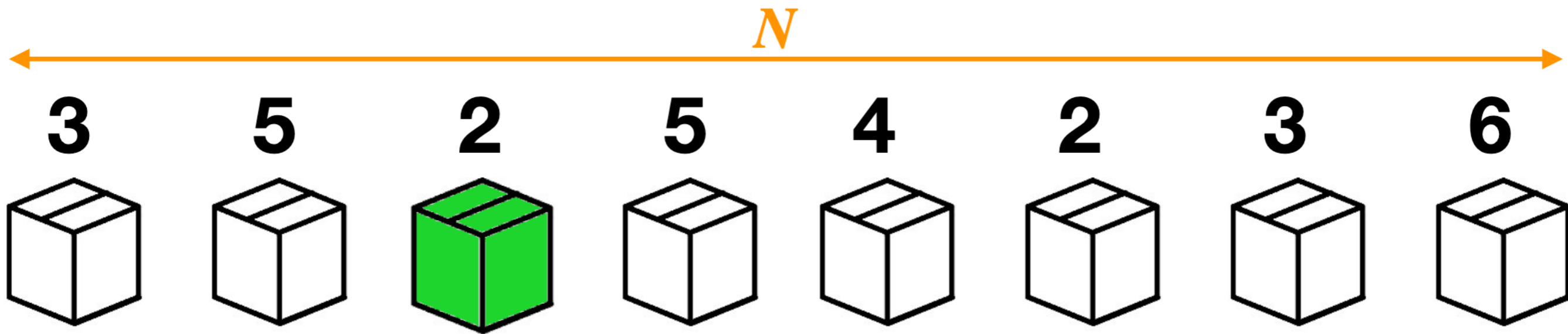

How many **queries** when the memory is limited to $\Theta(\log N)$ (qu)bits?

Classical

Quantum

Minimum Finding

$$\Theta(N)$$

$$\Theta(\sqrt{N})$$

[DH96, BBBV97]

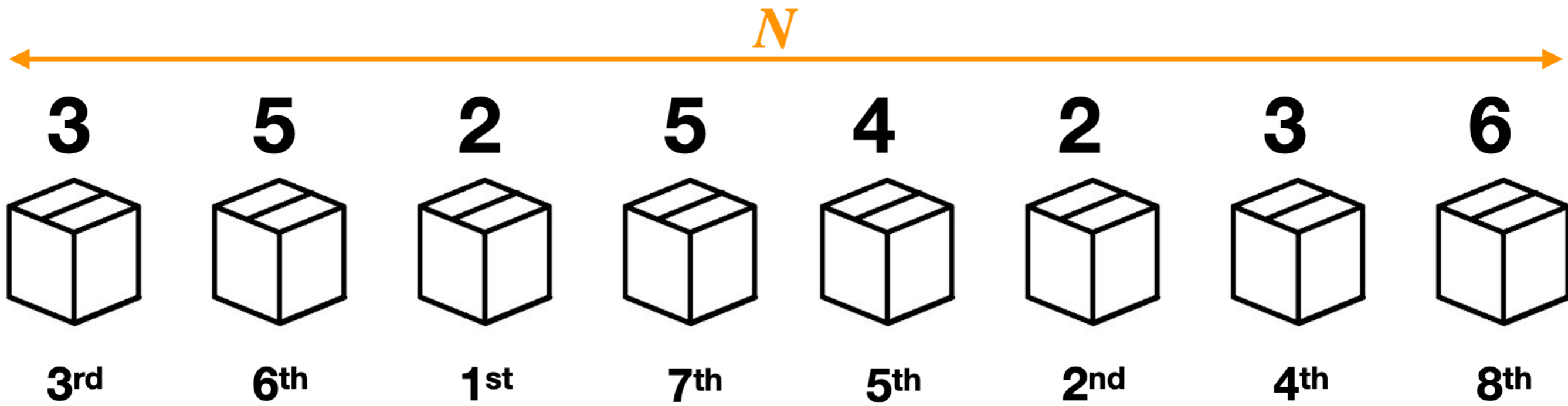

How many **queries** when the memory is limited to $\Theta(\log N)$ (qu)bits?

	Classical	Quantum
Minimum Finding	$\Theta(N)$	$\Theta(\sqrt{N})$
Sorting	$\tilde{\Theta}(N^2)$ [BC82]	$\tilde{\Theta}(N^{3/2})$ [KŠdW07]

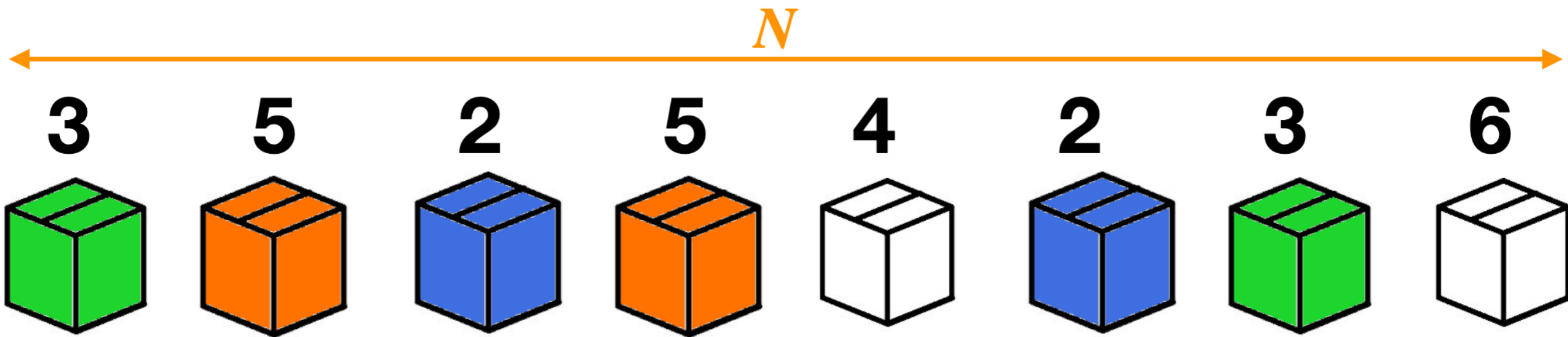

How many **queries** when the memory is limited to $\Theta(\log N)$ (qu)bits?

	Classical	Quantum
Minimum Finding	$\Theta(N)$	$\Theta(\sqrt{N})$
Sorting	$\tilde{\Theta}(N^2)$	$\tilde{\Theta}(N^{3/2})$
Collision Pairs Finding (random $f : [N] \rightarrow [N]$)	$\tilde{\Theta}(N^{3/2})$?

[vOW99, Din20]

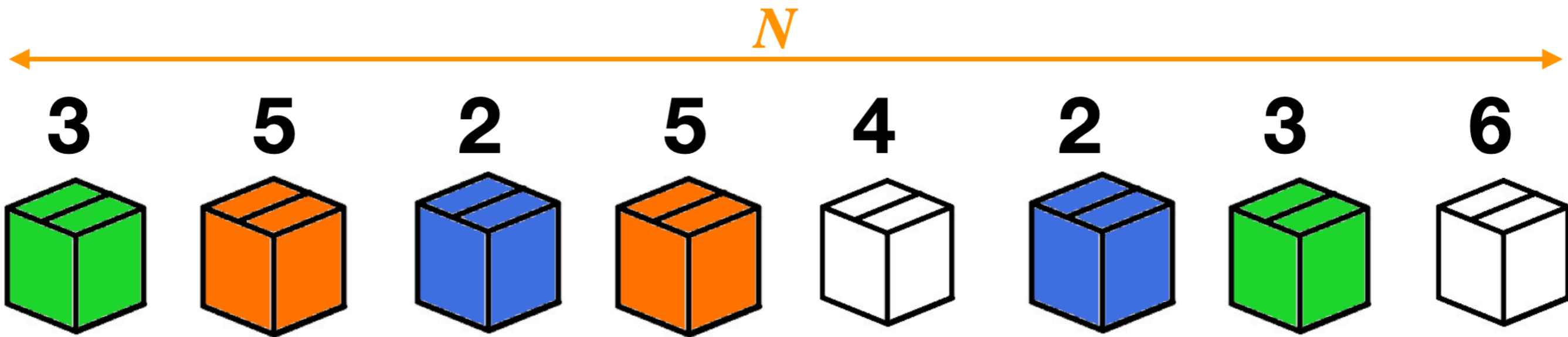

How many **queries** when the memory is limited to $\Theta(\log N)$ (qu)bits?

	Classical	Quantum
Minimum Finding	$\Theta(N)$	$\Theta(\sqrt{N})$
Sorting	$\tilde{\Theta}(N^2)$	$\tilde{\Theta}(N^{3/2})$ <i>Simpler proof</i>
Collision Pairs Finding (random $f : [N] \rightarrow [N]$)	$\tilde{\Theta}(N^{3/2})$	$\tilde{\Omega}(N^{4/3})$



Techniques

Small success probability regime:

Any algorithm that finds $\approx \log(N)$ collisions with success probability $\geq 1/N$ must use $\tilde{\Omega}(N^{1/3})$ quantum queries.

Even if the memory is unlimited

Lower bound method based on a simpler and generalized version of the **recording query technique** of [Zhandry'19].

Conclusion

